

Signal Integrity Analysis of 28 Gbit/s High-Speed Digital Signal

MP1800A Series
Signal Quality Analyzer

1. High-speed interconnect market trends

The rapid spread of cloud computing services and smart phones is causing a steady increase in network transmission capacities. The momentary traffic at some Internet exchanges is approaching 1 Tbit/s (see Fig. 1-1). As IT equipment counts increase in response to the greater traffic, power consumption requirements pose an even greater challenge.

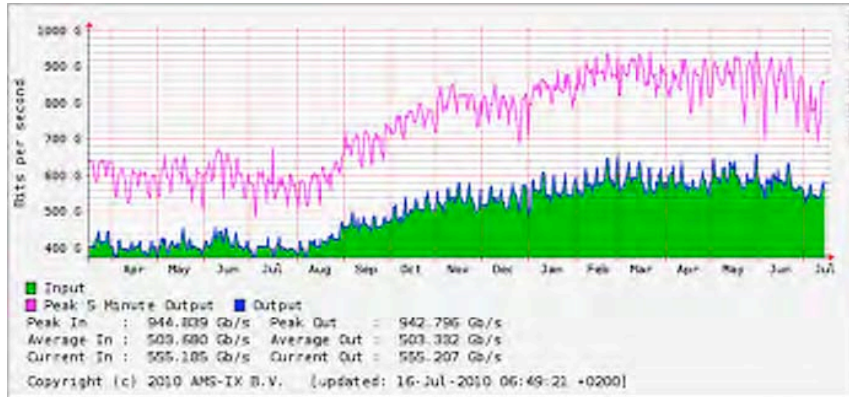

Fig. 1-1 2009-2020 monthly traffic trends

Source: AMS-IX

Increased device integration data rates and transmission speeds are effective methods for increasing the amount of processed data while minimizing power consumption. Currently, the 28-nm processes being introduced to the market can support data rates in the 28-Gbit/s band, effectively reducing power consumption per Gbit/s. Table 1-1 shows the established specifications for standards in the 20-Gbit/s band.

Table 1-1 Standards for data rates in 20-Gbit/s band

Standard	Data Rate	Lane
CEI-25G-SR	19.90 to 28.05 Gbit/s	1 to N
CEI-25G-LR	19.90 to 25.80 Gbit/s	1 to N
IEEE802.3ba 100GBASE-LR/ER	25.78125 Gbit/s	4
Infiniband 26G-IB-EDR	25.78125 Gbit/s	1 to N
32G Fiber Channel	28.05 Gbit/s	1

To maintain signal and power integrity at 28 Gbit/s high data rate, there are some important challenges that must first be resolved. This document discusses some of the challenges to maintaining signal integrity at higher transmission speeds.

2. Reduction in signal integrity caused by increasing signal speed

Designing logic circuits for only a few Mbit/s required little concern about overall signal integrity. As long as engineers applied experience and intuition - paying attention to parts layout, positioning smoothing capacitors on the power line, and adding terminating resistors on the signal line - signal integrity was relatively easily maintained.

For example, if noise of a 100 mVp-p overlays an LVTTTL signal of 3.3 Vp-p, the margin is reduced by only 3.3%. Or if the propagation delay characteristics of an FR-4 PCB are 70 [ps/cm], then a delay of 70 ps occurs when the wiring length differs by 1 cm. When a 100-Mbit/s signal is transmitted on a line, this same FR-4 PCB with a wiring length that differs by 1 cm, a deviation of 70 ps occurs for 1-bit 10 ns, and a phase difference of only 0.7% occurs. This does not greatly affect signal integrity.

But what happens when the data rate is increased to the 20 Gbit/s band?

To increase the data rate while maintaining amplitude, the rising and falling times must be faster. Using this type of output circuit generates issues such as increased power consumption and higher product prices. As frequency is increased, signal amplitudes are typically lower and bit periods significantly shorter. Therefore, whatever impacts amplitude or phase has a much greater impact on signal integrity, resulting in lower margins and a higher probability of errors. For this reason, low-amplitude signals are usually used. The physical length differences between signal paths, especially two sides of a different pair, become important to manage.

If noise of 100 mVp-p overlays a signal amplitude of 400 mVp-p, the threshold margin is reduced by as much as 25 percent (see Fig. 2-1). When a 25-Gbit/s signal is transmitted on a line of an FR-4 printed circuit board (PCB) with a wiring length that differs by 1 cm, a phase difference of more than 1 bit occurs due to a deviation of 70 ps for 1-bit 40 ps. This greatly affects signal integrity (see Fig. 2-2).

Consequently, because it is difficult to maintain signal integrity for data rates in the 20-Gbit/s band, thorough simulation and verification is essential.

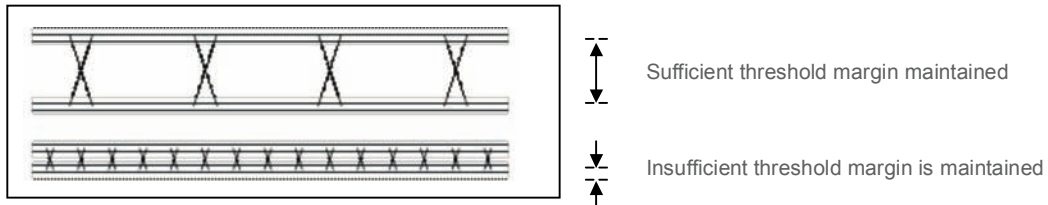

The threshold margin is reduced with the same amount of noise and a low-amplitude signal.

Fig. 2-1 Threshold margin difference

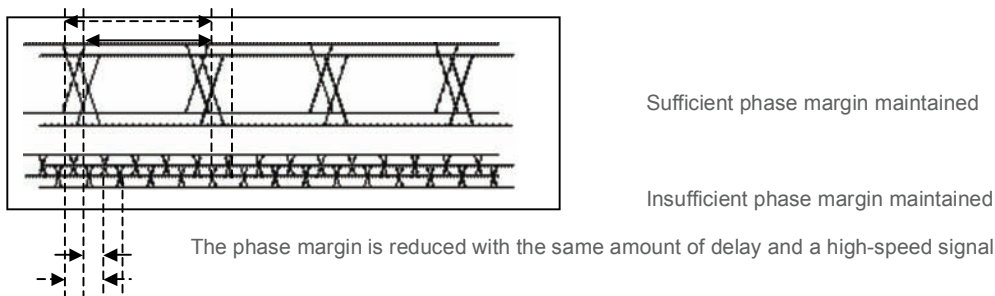

Fig. 2-2 Phase margin difference

3. Signal integrity analysis

As previously stated, when the data rate is increased, the effect on issues such as noise and error margin of pattern layouts can no longer be ignored.

In addition, there are many other physical phenomena, such as jitter, inter-symbol interference (ISI) and crosstalk, which contribute to reduced signal integrity. These phenomena cannot be eliminated completely at high data rates. Therefore, it is important to take into account the signal integrity reduction for both the transmitter circuit and the receiver circuit to ensure the quality of the output signal and receiver tolerance. This section describes the analysis method for securing the quality of the output signal and the receiver tolerance in terms of jitter, ISI and crosstalk.

- Jitter Evaluation
- ISI Evaluation
- Crosstalk Evaluation

3-1. Jitter evaluation

3-1-1. What is jitter?

Jitter is fluctuation in the time-axis direction of a digital signal. In a cycle less than 10 Hz, this fluctuation is called "wander," while fluctuation above 10 Hz is called "jitter." Figure 3-1 shows an ideal signal and a signal that has jitter with a sine wave component. As shown, the jitter component causes a reduction in the phase margin, making it difficult to maintain the setup and hold times necessary for logic evaluation. Thus, errors are generated.

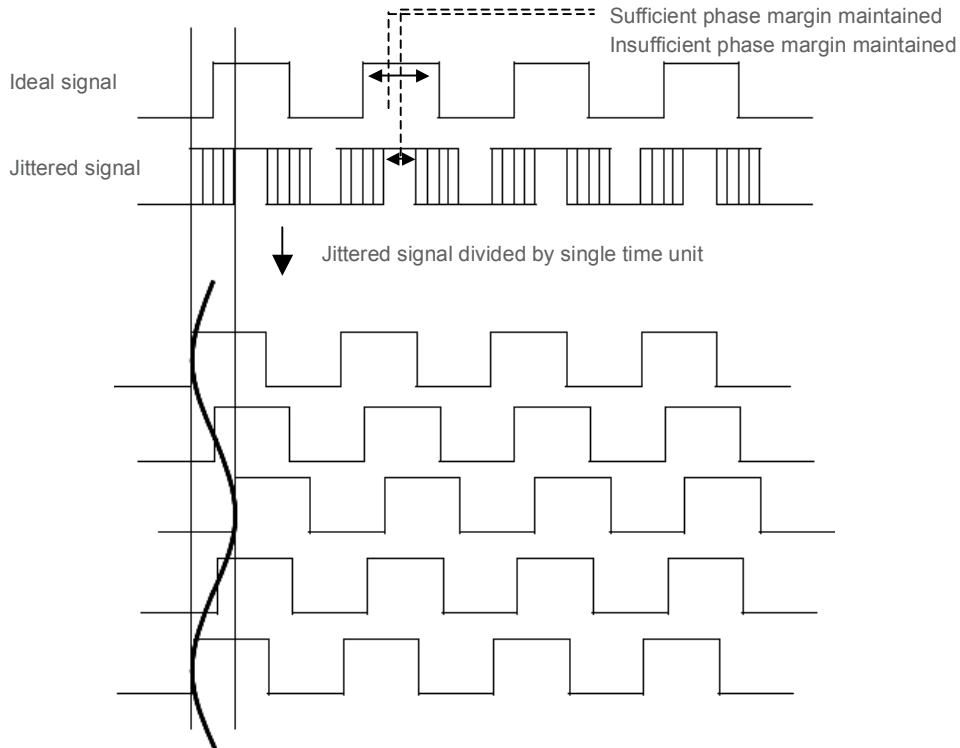

Fig. 3-1 Comparison of ideal and jittered signals

Figure 3-2 describes an example of jitter with a sine wave component only. However, actual jitter is comprised of various components. Total jitter (TJ) is comprised of deterministic jitter (DJ) with a bounded pattern, and random jitter (RJ) with an unbounded pattern. In addition, DJ is derived from data-dependent jitter (DDJ) that is correlated to the signal pattern, and bounded uncorrelated jitter (BUJ) that is not correlated to the signal pattern. DDJ comes from duty cycle distortion (DCD) that is dependent on the characteristics of the input and output circuit, and ISI that is dependent on characteristics such as the transmission path.

Figure 3-2 and Table 3-1 show jitter component types in actual signals and explain their characteristics.

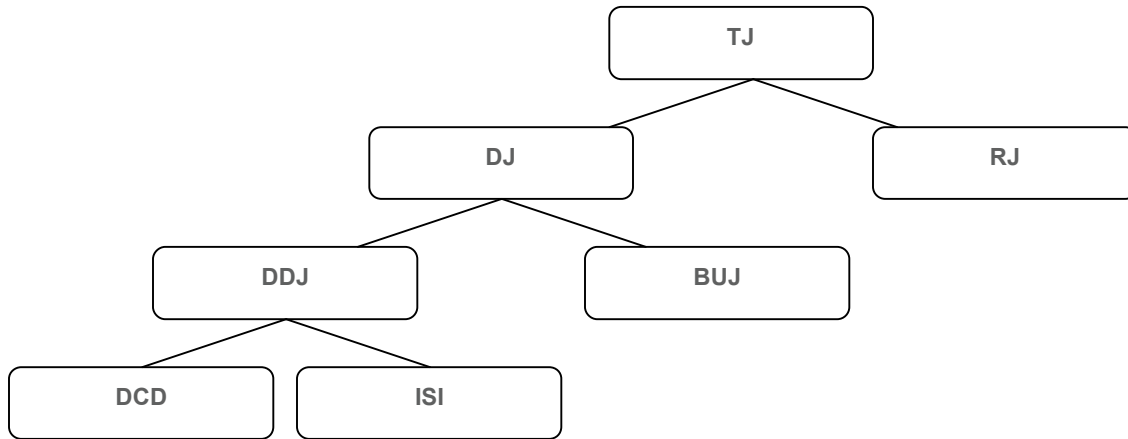

Fig. 3-2 Jitter Types

Table 3-1 Jitter causes and characteristics

Name	Causes and Characteristics
RJ Random Jitter	Jitter caused by external factors such as thermal noise. With an unbounded pattern, it typically follows a Gaussian distribution. Because it has an unbounded pattern, it is expressed in rms.
BUJ Bounded Uncorrelated Jitter	Jitter caused by external factors such as the effect of crosstalk from nearby signal lines. It has random characteristics similar to random jitter, but because it has a bounded pattern, it is expressed in p-p.
DCD Duty Cycle Distortion	Phenomenon caused by factors such as deviation in the offset of the transmission and reception circuits. This is the difference between the Hi pulse width and the Low pulse width.
ISI Intersymbol Interference	Phenomenon caused by factors such as insufficient bandwidth in the transmission path or reflections due to an impedance mismatch. It is the difference between the fastest and slowest rising or the fastest and lowest falling after the components with no correlation to the data are removed.

3-1-2. Jitter tolerance evaluation

An effective method for evaluating jitter reception tolerance for a device is to receive a signal for which pseudo-imposition of jitter has been performed, measure the bit-error rate (BER), and evaluate the resistance. As described in section 3-1-1, actual signals are comprised of various jitter components, and the same components must be reproduced and imposed. Sinusoidal jitter (SJ) is commonly used to simulate deterministic jitter (DJ) in a test environment. A typical block diagram for jitter generation is shown in Fig. 3-3.

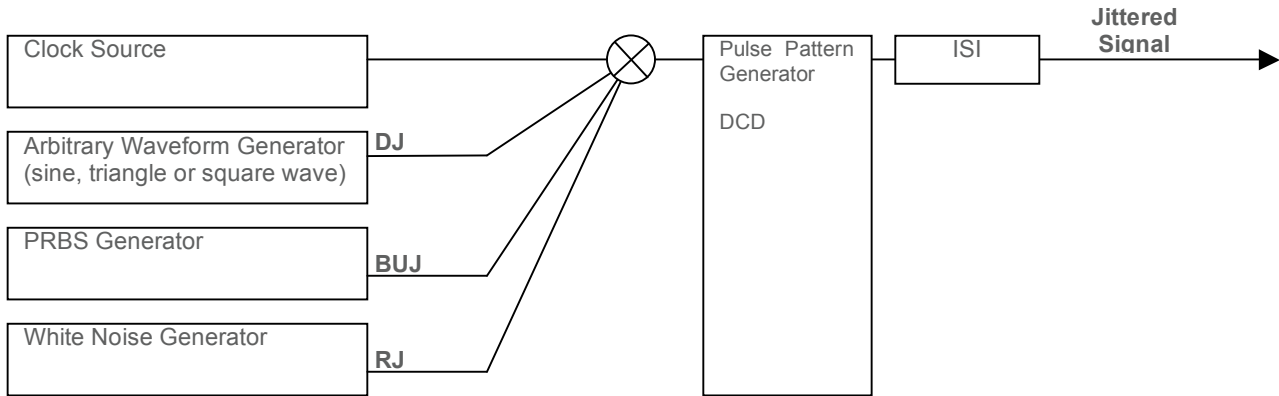

Fig. 3-3 Block diagram for jitter generators

Figure 3-4 shows each jitter component of the data waveform and its spectrum distribution.

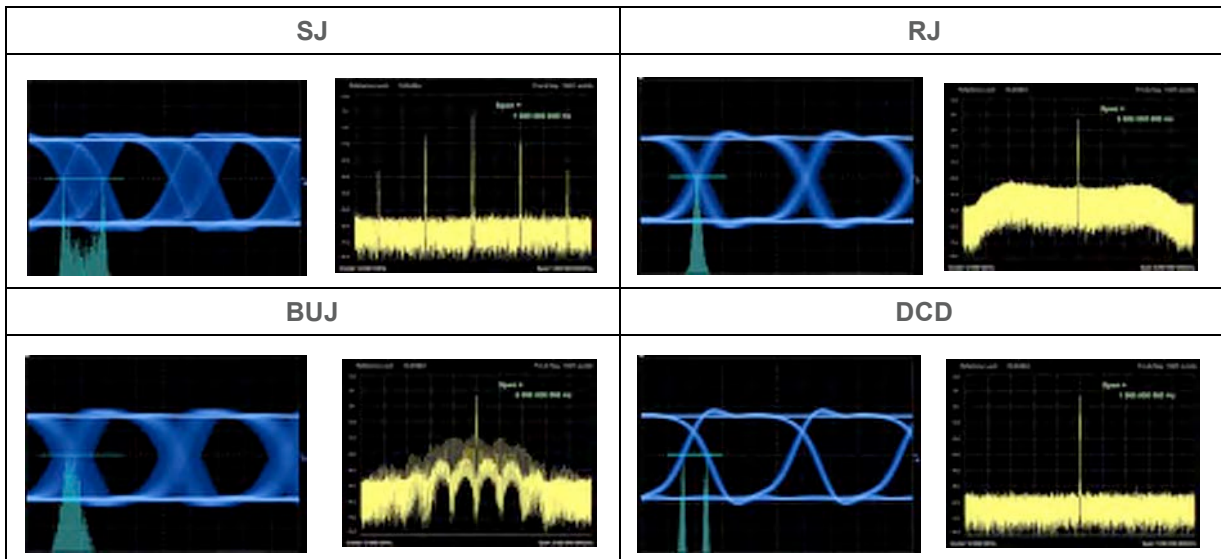

Fig. 3-4 Jitter histogram and spectrum distribution

3-1-3. Jitter analysis using “the bathtub curve”

At bathtub measurement, the distribution of bit errors caused by fluctuation in phase direction is measured inside the eye opening of the digital signal. The TJ, RJ, DJ and optimum phase, along with the corresponding optimum bit error rate, are then calculated (see Fig. 3-5). A TJ closer to the optimum BER is attainable by measuring the BER at 10^{-12} (see Fig. 3-6).

The calculation method shown below uses the two-point measurement of BER E-6 and E-12 introduced as Level 1 in MJSQ (Fiber Channel- Methodologies for Jitter and Signal Quality Specification).

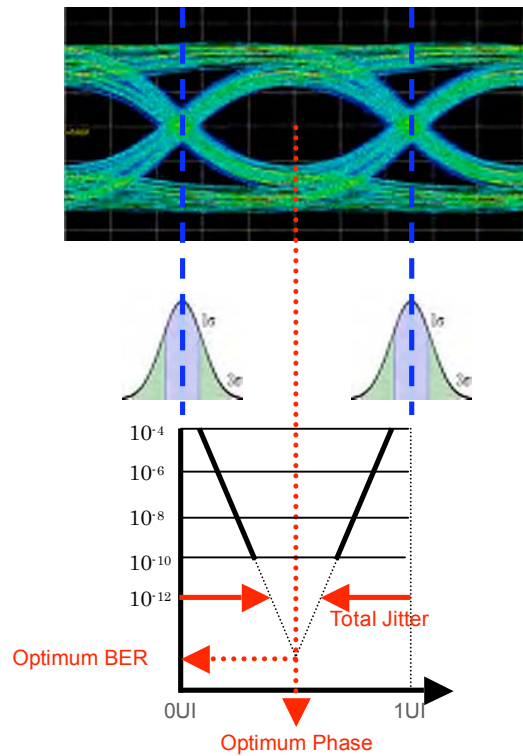

Fig. 3-5 Bathtub measurement concept

In general, RJ follows a normal distribution, and TJ is calculated using the following equation:

$$TJ_{pk-pk} = UI - t_1 = DJ_{pk-pk} + n RJ_{rms}$$

UI: Bit cycle

t_1 : Measured values of phases for eye opening at BER E-12

n: $n = 13.68$ (BER 1.0E-12) that is expressed with the TJ normal distribution in the specified BER

Next, TJ, DJ and RJ_{RMS} are calculated using the following equations.

$$TJ = UI - t_1 = DJ + 2 \times Q_1 \times RJ_{RMS}$$

$$DJ = UI - t_0 - (2 \times Q_0 \times RJ_{RMS})$$

$$RJ_{RMS} = 0.5|(t_1 - t_0)/(Q_1 - Q_0)|$$

Q₀, Q₁: Calculated values of reverse cumulative probability distribution for BER E-6 and E-12

$$Q_0 = -\text{qnorm} [(2/TD) \times 10^{-6}, 0, 1]$$

$$Q_1 = -\text{qnorm} [(2/TD) \times 10^{-12}, 0, 1]$$

(TD: Transition Density = Mark Ratio)

When TD=1/2, Q₀ = 4.465 and Q₁ = 6.839

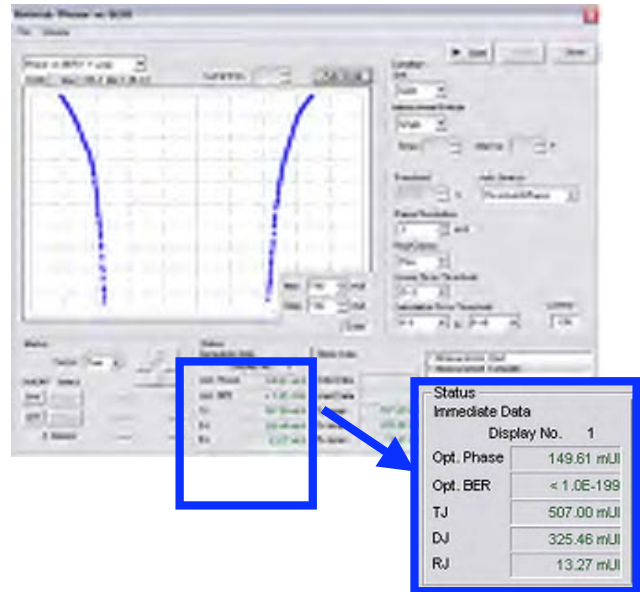

Fig. 3-6 Bathtub measurement

3-2. ISI analysis

3-2-1. What is ISI?

ISI is waveform distortion or attenuation that occurs when a data signal passes through a transmission path, such as a PCB, with frequency-dependent loss. As the data rate increases, ISI makes it more difficult for the signal to pass, mainly due to the effects of 1) the frequency characteristics of the transmission path, 2) the skin effect, and 3) the dielectric loss. Thus, the signal attenuates and the eye pattern closes. Figure 3-7 shows the effect of ISI using a PCB.

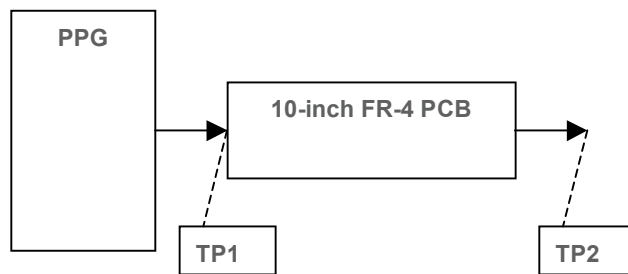

Fig. 3-7 ISI effect evaluation system

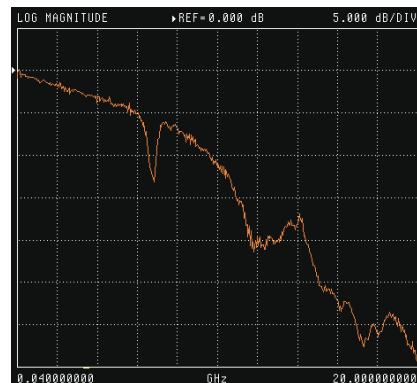

Fig 3-8 PCB frequency characteristics

As shown in Fig. 3-8, since the PCB causes more than 30 dB of attenuation at 20 GHz, the 20-Gbit/s waveform eye pattern closes due to the effect of ISI, making it difficult to transmit error-free data (see Fig. 3-9).

	TP1 Before passage of signal through PCB	TP2 After passage of signal through PCB
10-Gbit/s waveform		
20-Gbit/s waveform		

Fig. 3-9 Effect of ISI on received data waveform

3-2-2. ISI correction using emphasis signals

It is not possible to completely eliminate ISI and transmit high-speed signals without any attenuation. As such, the ISI must be corrected to maintain the eye opening. A transmission technique called pre-emphasis is effective for maintaining the eye opening. Emphasis boosts high-frequency components of a signal to compensate for higher attenuation in the transmission channel. Since high-frequency components suffer the most attenuation, emphasis technology is used to emphasize the bits where this signal transition occurs, helping to suppress signal attenuation.

Figure 3-10 compares the attenuation amount when using a normal non-return-to-zero (NRZ) signal and a four-tap emphasis signal. At the highest frequency part using the emphasis signal, the amplitude increases to 410 mVp-p from 150 mVp-p, an improvement of about 173 percent.

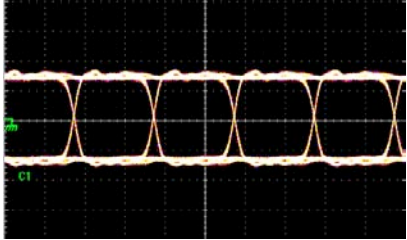
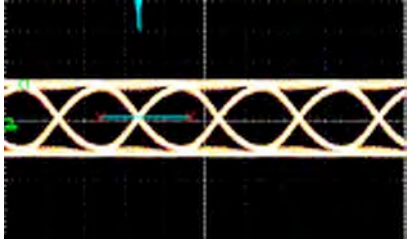
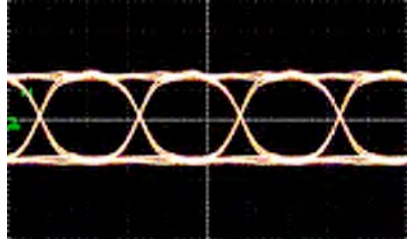
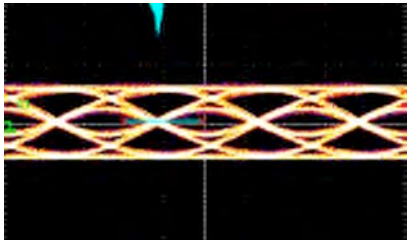
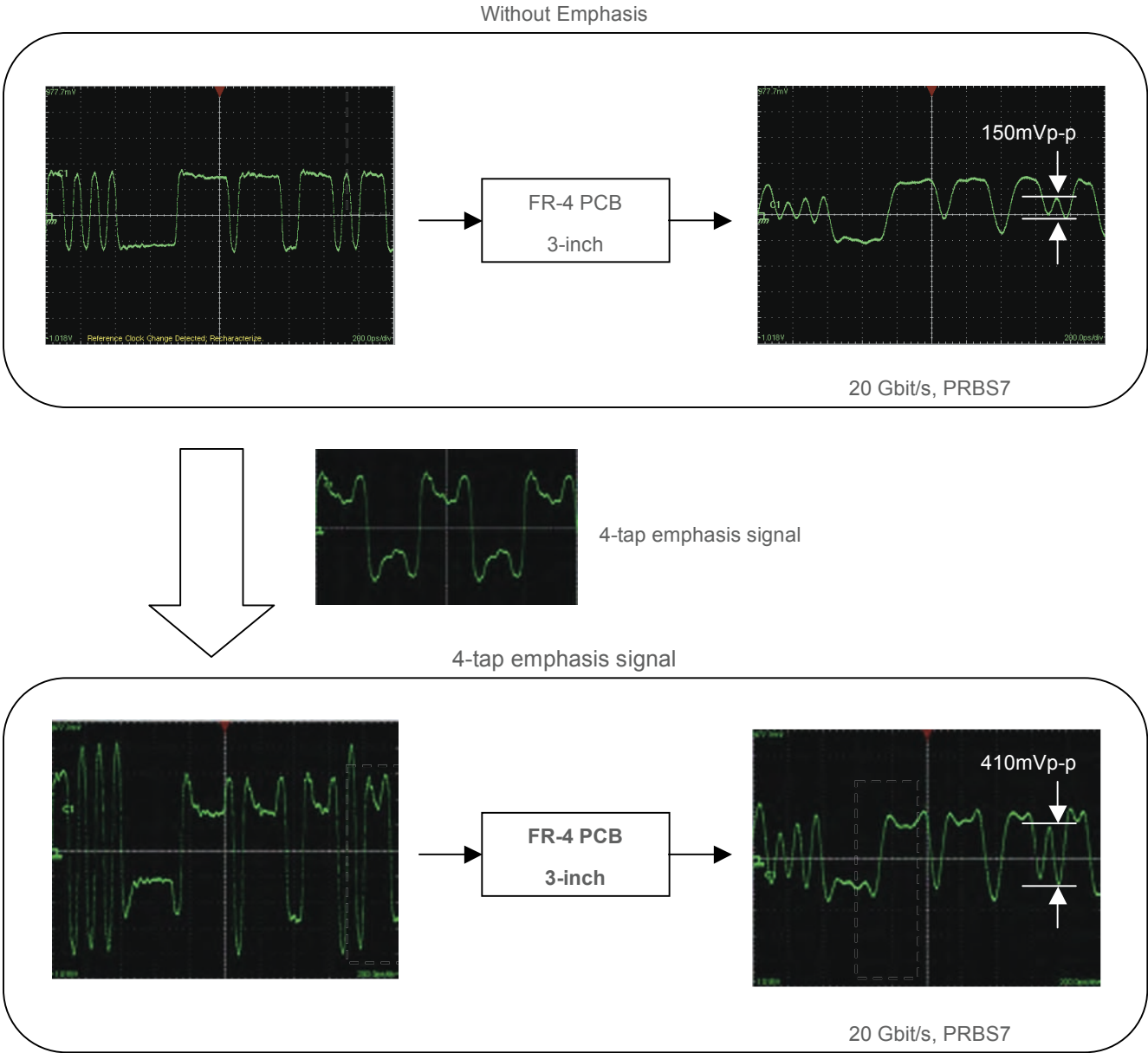
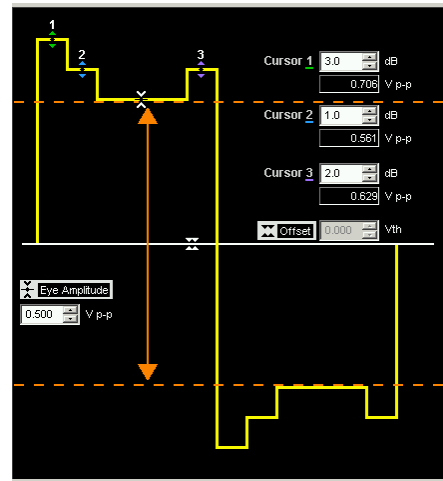

Fig. 3-10 Attenuation improvement using emphasis

Figure 3-11 depicts the change in the degree of the eye opening with different emphasis taps. At a bit rate of 10 Gbit/s, the eye opening becomes largest when four-tap emphasis is applied (3 dB at cursor 1, 1 dB at cursor 2, and 2 dB at cursor 3). The improvement is about 23 percent.



Number of taps	TP1 Before passage of signal through PCB	TP2 After passage of signal through PCB	Eye amplitude
1 Tap Eye Amplitude = 500 mVp-p Cursor 1 : 0 dB Cursor 2 : 0 dB Cursor 3 : 0 dB			312 mVp-p
2 Taps Eye Amplitude = 500 mVp-p Cursor 1 : 3 dB Cursor 2 : 0 dB Cursor 3 : 0 dB			361 mVp-p
3 Taps Eye Amplitude = 500 mVp-p Cursor 1 : 3 dB Cursor 2 : 0 dB Cursor 3 : 2 dB			347 mVp-p
4 Taps Eye Amplitude = 500 mVp-p Cursor 1 : 3 dB Cursor 2 : 1 dB Cursor 3 : 2 dB			384 mVp-p

Fig. 3-11 Effect of emphasis for each tap number at 10 Gbit/s

At a bit rate of 20 Gbit/s, the eye opening becomes largest with four-tap emphasis (6 dB at cursor 1, 1 dB at cursor 2, and 6 dB at cursor 3), and the improvement is about 194 percent (see Fig.3-12).

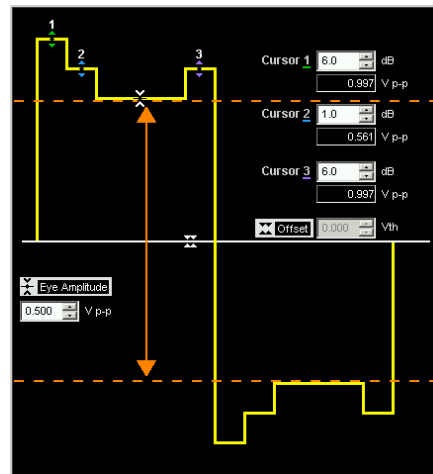

Number of taps	TP1 Before passage of signal through PCB	TP2 After passage of signal through PCB	Eye amplitude
1 Tap Eye Amplitude = 500 mVp-p Cursor 1 : 0 dB Cursor 2 : 0 dB Cursor 3 : 0 dB			113mVp-p
2 Taps Eye Amplitude = 500 mVp-p Cursor 1 : 6 dB Cursor 2 : 0 dB Cursor 3 : 0 dB			178 mVp-p
3 Taps Eye Amplitude = 500 mVp-p Cursor 1 : 6 dB Cursor 2 : 0 dB Cursor 3 : 6 dB			295 mVp-p
4 Taps Eye Amplitude = 500 mVp-p Cursor 1 : 6 dB Cursor 2 : 1 dB Cursor 3 : 6 dB			333 mVp-p

Fig. 3-12 Effect of emphasis for each tap number at 20 Gbit/s

3-3. Crosstalk

3-3-1. What is crosstalk?

Crosstalk occurs when a signal leaks from a nearby signal line. When large crosstalk occurs, it reduces the signal integrity and causes incorrect operations. There are two main causes of crosstalk – mutual capacitance and mutual inductance. In the example shown in Figure 3-13, Signal Line A (Aggressor) is causing the effect and Signal Line B (Victim) is receiving the effect. Signal Line A's signal leaks to Signal Line B due to mutual capacitance and mutual inductance. As the signal leaks, it reduces the signal integrity (see Figure 3-14). A characteristic of mutual capacitance and mutual inductance is that the crosstalk effect increases as the edge speed rises.

When the signal leaks from the transmitter end of the Aggressor to interfere with the transmitter end of the Victim, it is called near-end crosstalk (NEXT). Interference with the receiver end of the Victim is called far-end crosstalk (FEXT).

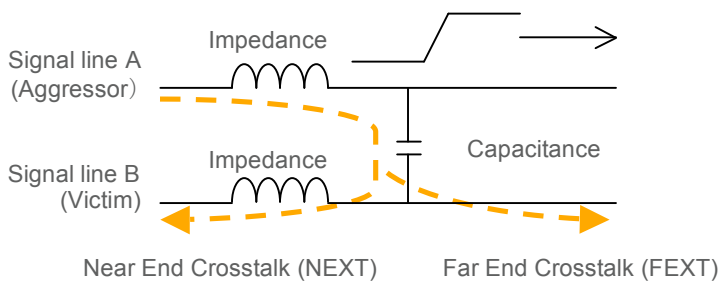

Fig. 3-13 Principle of crosstalk

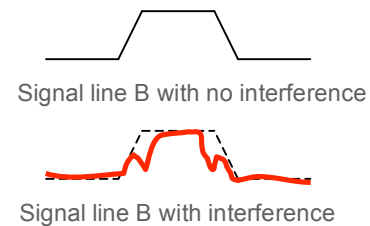

Fig. 3-14 Effect on signal of crosstalk

A closer look reveals that the crosstalk effect also varies with the timing of the Aggressor and Victim. As shown in Fig. 3-15, the delay is increased when change is performed in a reversed phase, while the delay is reduced when the change is in the same phase. When only the Aggressor is changed, the delay does not change. However, waveform distortion occurs. Additionally, the worse case situation takes place when the crosstalk occurs in the middle of the Victim eye, rather than the edges where the transitions occur, since the data is usually sampled in the middle.

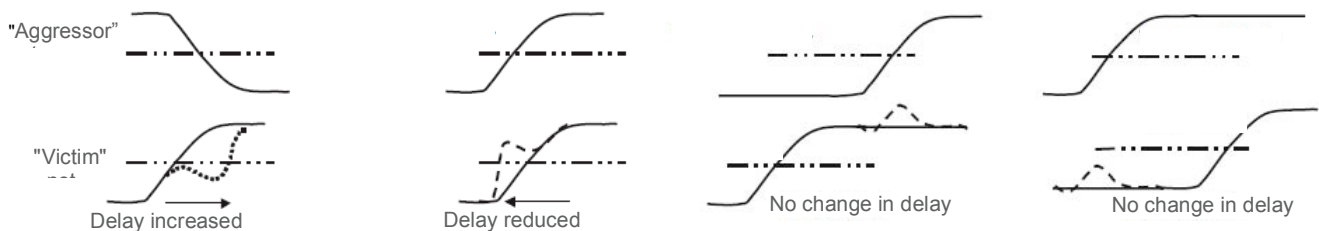

Fig. 3-15 Effects of crosstalk on waveform

3-3-2. Checking for crosstalk

When checking for crosstalk, it is important to transmit signals to both the Victim line and Aggressor line to generate the crosstalk.

The effect of crosstalk is checked using waveform observation after inputting the signal from the programmable pulse generator (PPG) to both Victim and Aggressor lines (see Fig. 3-16). As shown by the waveform on the left, the high and low of the input waveform are flat and clear. However, ringing occurs for the output waveform from the signal line, as shown by the waveform on the right. This is the effect of signal leak from the adjacent signal line, so the occurrence of crosstalk can be confirmed using an oscilloscope.

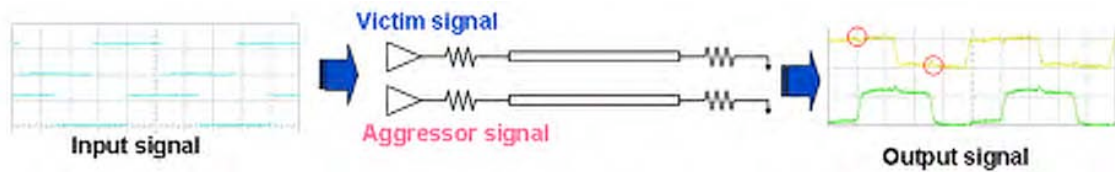

Fig. 3-16 Waveform of signal receiving crosstalk effect

Next, the spectrum is checked by transmitting a sine wave signal to the Victim line and an "all-zeros" pattern to the Aggressor line (see Fig. 3-17). In this case, there is no crosstalk effect because no signal is transmitted to the Aggressor line, as shown by the waveform. However, when a PRBS7 pattern is transmitted to the Aggressor line, crosstalk is received and noise is overlaid. Therefore, the spectrum distribution can also be used to confirm that PRBS7 spectrum components are overlaid on the floor.

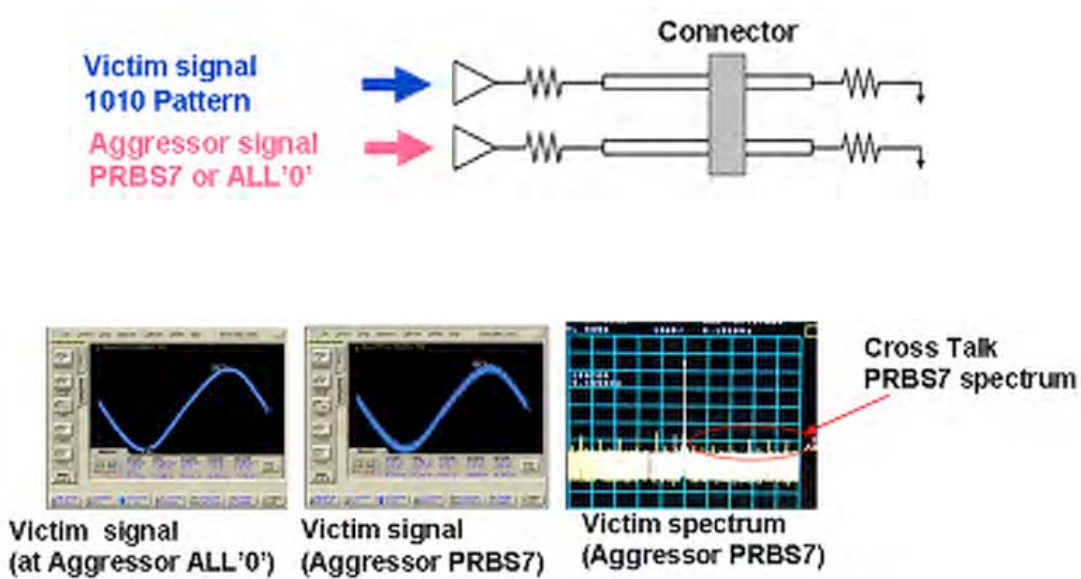

Fig. 3-17 Spectrum distribution of signal affected by crosstalk

4. Conclusion

For interconnect technologies using high-speed signals of 20 Gbit/s or higher, closer attention must be given to physical phenomena that can impact signal integrity. Three measurement solutions are available for evaluating jitter, ISI, and crosstalk and properly employing the necessary countermeasures to ensure signal integrity.

New challenges must be resolved for future research and development initiatives to move forward. With the accelerating trend toward higher-speed interconnects, Anritsu will continue to rapidly respond to these challenges with effective test and measurement solutions.

NOTES

Anritsu Corporation

5-1-1 Onna, Atsugi-shi, Kanagawa, 243-8555 Japan
Phone: +81-46-223-1111
Fax: +81-46-296-1238

● U.S.A.

Anritsu Company

1155 East Collins Blvd., Suite 100, Richardson,
TX 75081, U.S.A.
Toll Free: 1-800-267-4878
Phone: +1-972-644-1777
Fax: +1-972-671-1877

● Canada

Anritsu Electronics Ltd.

700 Silver Seven Road, Suite 120, Kanata,
Ontario K2V 1C3, Canada
Phone: +1-613-591-2003
Fax: +1-613-591-1006

● Brazil

Anritsu Eletrônica Ltda.

Praça Amadeu Amaral, 27 - 1 Andar
01327-010 - Bela Vista - São Paulo - SP - Brasil
Phone: +55-11-3283-2511
Fax: +55-11-3288-6940

● Mexico

Anritsu Company, S.A. de C.V.

Av. Ejército Nacional No. 579 Piso 9, Col. Granada
11520 México, D.F., México
Phone: +52-55-1101-2370
Fax: +52-55-5254-3147

● U.K.

Anritsu EMEA Ltd.

200 Capability Green, Luton, Bedfordshire, LU1 3LU, U.K.
Phone: +44-1582-433200
Fax: +44-1582-731303

● France

Anritsu S.A.

12 avenue du Québec, Bâtiment Iris 1- Silic 612,
91140 VILLEBON SUR YVETTE, France
Phone: +33-1-60-92-15-50
Fax: +33-1-64-46-10-65

● Germany

Anritsu GmbH

Nemetschek Haus, Konrad-Zuse-Platz 1
81829 München, Germany
Phone: +49-89-442308-0
Fax: +49-89-442308-55

● Italy

Anritsu S.r.l.

Via Elio Vittorini 129, 00144 Roma, Italy
Phone: +39-6-509-9711
Fax: +39-6-502-2425

● Sweden

Anritsu AB

Borgafjordsgatan 13, 164 40 KISTA, Sweden
Phone: +46-8-534-707-00
Fax: +46-8-534-707-30

● Finland

Anritsu AB

Teknobulevardi 3-5, FI-01530 VANTAA, Finland
Phone: +358-20-741-8100
Fax: +358-20-741-8111

● Denmark

Anritsu A/S (Service Assurance)

Anritsu AB (Test & Measurement)

Kirkebjerg Allé 90, DK-2605 Brøndby, Denmark
Phone: +45-7211-2200
Fax: +45-7211-2210

● Russia

Anritsu EMEA Ltd.

Representation Office in Russia

Tverskaya str. 16/2, bld. 1, 7th floor.
Russia, 125009, Moscow
Phone: +7-495-363-1694
Fax: +7-495-935-8962

● United Arab Emirates

Anritsu EMEA Ltd.

Dubai Liaison Office

P O Box 500413 - Dubai Internet City
Al Thuraya Building, Tower 1, Suit 701, 7th Floor
Dubai, United Arab Emirates
Phone: +971-4-3670352
Fax: +971-4-3688460

● Singapore

Anritsu Pte. Ltd.

60 Alexandra Terrace, #02-08, The Comtech (Lobby A)
Singapore 118502
Phone: +65-6282-2400
Fax: +65-6282-2533

● India

Anritsu Pte. Ltd.

India Branch Office

3rd Floor, Shri Lakshminarayan Niwas, #2726, 80 ft Road,
HAL 3rd Stage, Bangalore - 560 075, India
Phone: +91-80-4058-1300
Fax: +91-80-4058-1301

● P.R. China (Hong Kong)

Anritsu Company Ltd.

Units 4 & 5, 28th Floor, Greenfield Tower, Concordia Plaza,
No. 1 Science Museum Road, Tsim Sha Tsui East,
Kowloon, Hong Kong
Phone: +852-2301-4980
Fax: +852-2301-3545

● P.R. China (Beijing)

Anritsu Company Ltd.

Beijing Representative Office

Room 2008, Beijing Fortune Building,
No. 5, Dong-San-Huan Bei Road,
Chao-Yang District, Beijing 100004, P.R. China
Phone: +86-10-6590-9230
Fax: +86-10-6590-9235

● Korea

Anritsu Corporation, Ltd.

8F Hyunjuk Building, 832-41, Yeoksam Dong,
Kangnam-ku, Seoul, 135-080, Korea
Phone: +82-2-553-6603
Fax: +82-2-553-6604

● Australia

Anritsu Pty. Ltd.

Unit 21/270 Ferntree Gully Road, Notting Hill,
Victoria 3168, Australia
Phone: +61-3-9558-8177
Fax: +61-3-9558-8255

● Taiwan

Anritsu Company Inc.

7F, No. 316, Sec. 1, Neihu Rd., Taipei 114, Taiwan
Phone: +886-2-8751-1816
Fax: +886-2-8751-1817

Please Contact: