

Anritsu envision : ensure

Wireless Connectivity Test Set

MT8862A



H a v e y o u
m e a s u r e d m e u p ?





MT8862A

Ideal for RF TRx Tests of WLAN Devices

Wireless communications over WLAN are increasing rapidly due to the widespread use of mobile terminals, such as smartphones, as well as integration of network-connected TVs, cleaners, automobiles, industrial equipment, sensors, and more, into the Internet of things (IoT). Makers of these equipment are anticipating more end-user enquiries related to WLAN performance, including network coverage, reception sensitivity, etc.

Anritsu's Wireless Connectivity Test Set is ideal for measuring the RF TRx characteristics at design and manufacturing inspection of WLAN devices. It has a built-in Network Mode for measuring the performance of the WLAN DUT under realistic operation conditions to play a key role in quality evaluation and improvement.

11ac

Supports Latest Standards

As well as supporting IEEE802.11a/b/g/n, the MT8862A supports the latest WLAN IEEE802.11ac standard to evaluate a broader range of WLAN-device RF TRx characteristics including Tx power, Rx sensitivity, and more.

Network Mode

Measurement under Realistic Operation Conditions

The MT8862A uses standard WLAN protocol messaging with a built-in Network Mode to establish a connection with the WLAN device and measure the RF TRx characteristics under realistic operation conditions.



Smartphone
Tablet



Smart appliances



Wearable device



Gateway



Automotive



Smart grid

Wireless Connectivity Test Set MT8862A

RF TRx Measurements of WLAN Equipment

The Wireless Connectivity Test Set MT8862A is designed for measuring the RF TRx characteristics of WLAN equipment. It has standard WLAN protocol messaging (WLAN signalling) to connect with the device under test (DUT) for measuring the TRx performance items as Network Mode.

Supported Communications Standards • Security encryption

WLAN IEEE802.11a/b/g/n/ac (2.4 GHz and 5 GHz bands) [AP/STA]
WEP, WPA-Personal, and WPA2-Personal



Wireless Connectivity Test Set
MT8862A

RF Performance Measurement under Actual Operation Conditions (Network Mode)

By using the MT8862A Network Mode, RF TRx characteristics, such as Tx power, modulation accuracy (EVM), etc., can be measured with the WLAN device in actual operation conditions. It is not necessary to put the DUT into dedicated test mode and directly control the DUT. The DUT RF performance can be quantified under the firmware conditions at actual shipment.

Easy Measurement Environment Configuration

The MT8862A can simulate access points (AP) and station (STA) to establish the DUT network connection using IEEE802.11a/b/g/n/ac WLAN protocol messaging. Each WEP, WPA-Personal and WPA2-Personal secure connection method is supported, and TKIP and AES encryption schemes can be selected by combination with each standard. When the connection is established, RF measurements can be made using general WLAN communications procedures without requiring special tools and control procedures, eliminating the need for configuring a special measurement environment.

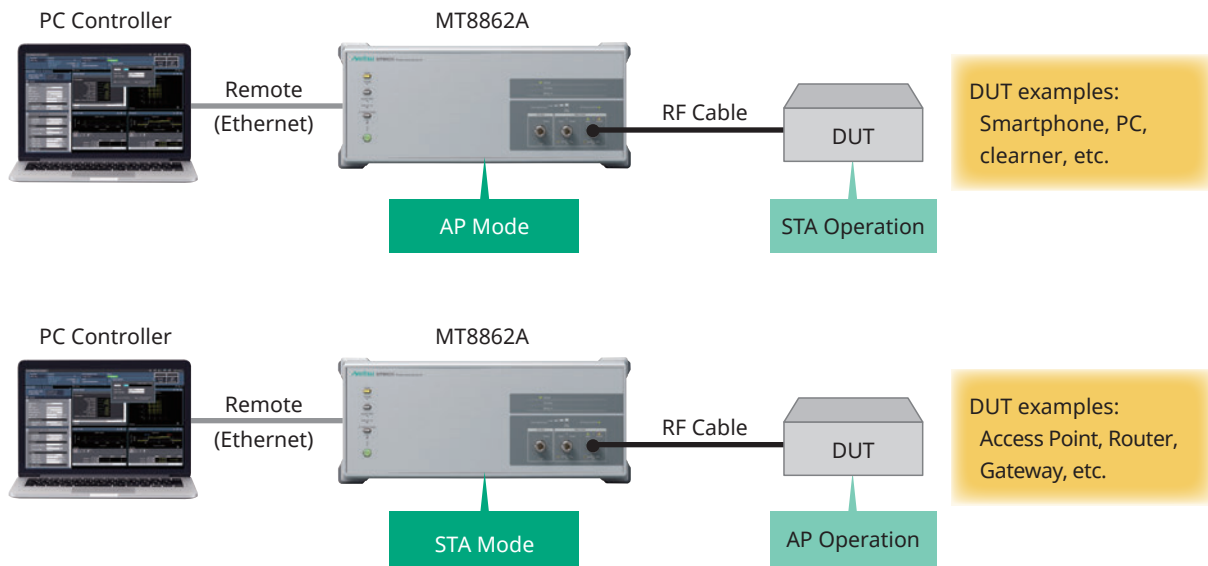

WLAN Measurement Software MX886200A Features

ICMP Echo Request for Tx Measurement

With the ICMP echo request, the MT8862A can measure RF Tx characteristics of reply packets from the DUT. The measurement targets are both data frames and ACK frames.

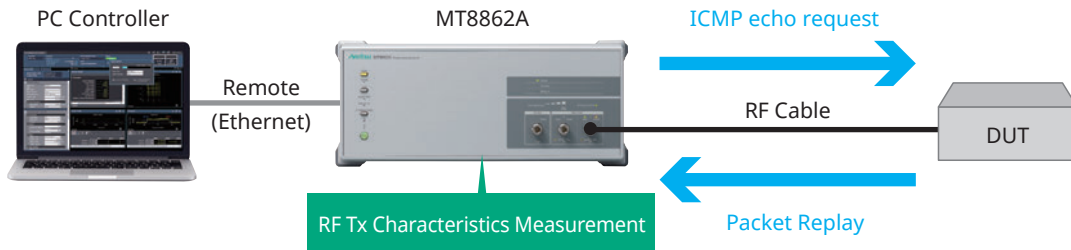

Rx Sensitivity Measurements using ACK Frame Count for Bathtub Curve Generation

The MT8862A supports Rx sensitivity measurements using the ACK frame count; counting the ACK frames sent by the DUT versus the test packets sent from the MT8862A supports calculation of the packet error rate (PER). Packets can be sent while lowering the power level by setting the power level range (0 to -120 dBm) and step size, and the Rx sensitivity Bathtub curve can be generated automatically. Packets including MAC address and payload length can be configured in real-time for measurement at various data rates.

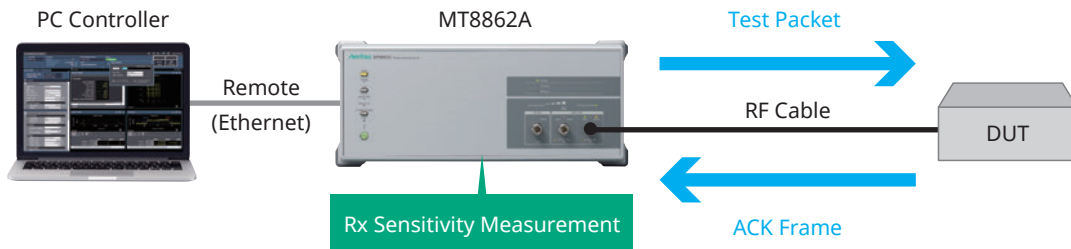

Web Browser GUI Operation Immediately after Connection

Connect the MT8862A to the external PC using an Ethernet cable for instant access from the Web browser to complete setup of the GUI operation environment without requiring test setup operation.

The Web-browser based GUI eliminates usage worries about version matching with the main frame firmware. Additionally, the MT8862A remote control port supports the DHCP client function and both host and domain name settings offer easy control simply by connecting the PC controller and MT8862A to the same network.

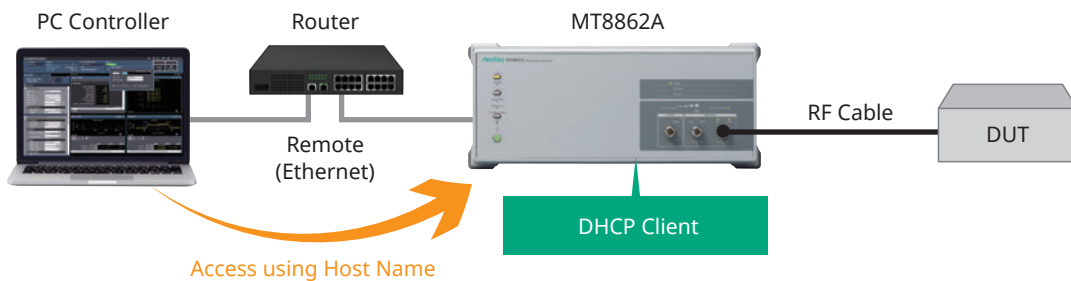

WLAN Measurement Software MX886200A Features

Function Test

Frame Capture Logging for Troubleshooting Connection Problems

With built-in frame capture logging function, the MT8862A can capture and save frame logs for troubleshooting DUT connection problems. Captured logs are in the *.pcap format for viewing by supported applications, making it easier to analyze DUT connection problems.

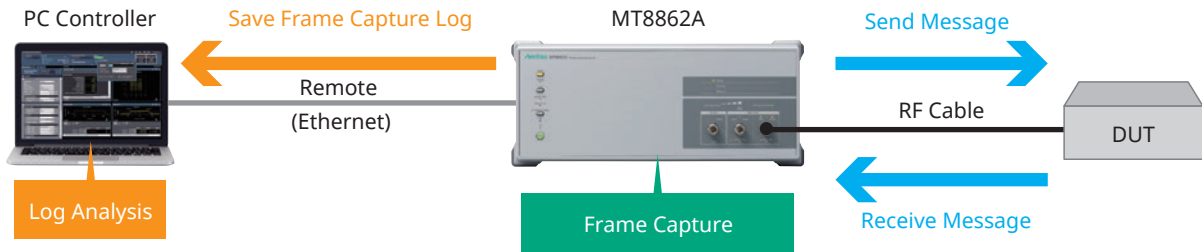

IP Data Transfer using Connection Verification Test

The Ethernet port on the back panel of the MT8862A can be used for exchanging IP data with an external server; IP connections between the client PC connected to the DUT and the external server connected to the MT8862A can be checked using the ping function, etc.

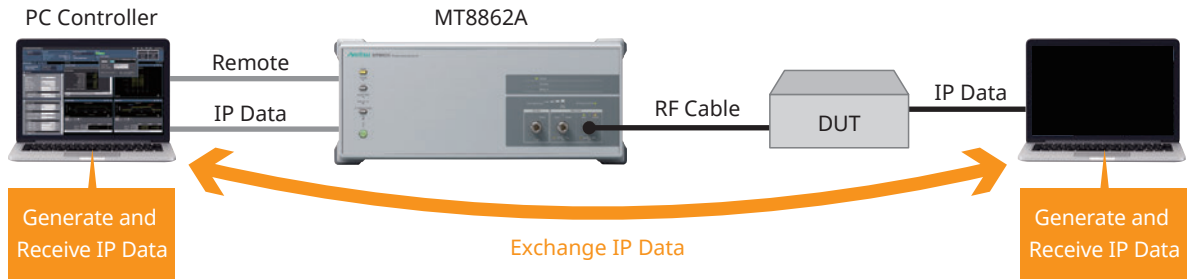

WLAN Measurement Software MX886200A Features

Application Test

Network Mode for Over The Air (OTA) Test

The TRx performance of wireless terminals is affected by factors such as the terminal form and antenna characteristics. The OTA test measures the general TRx performance of the wireless terminal using actual radio waves. The WLAN OTA test measures RF performance specifications in accordance with the recommendations of CTIA* and the Converged Wireless Group (CWG) of the Wi-Fi Alliance, including Total Radiated Power (TRP), Total Isotropic Sensitivity (TIS), making the MT8862A an ideal test solution for future system integrators.

*: Cellular Telecommunications & Internet Association; international non-profit organization composed of wireless-communications-related businesses, manufacturers, service providers, etc.

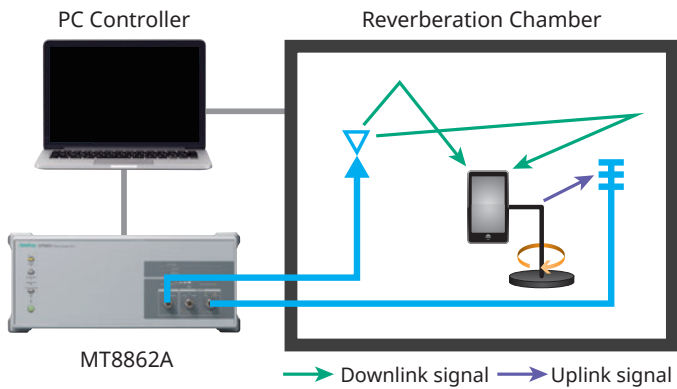
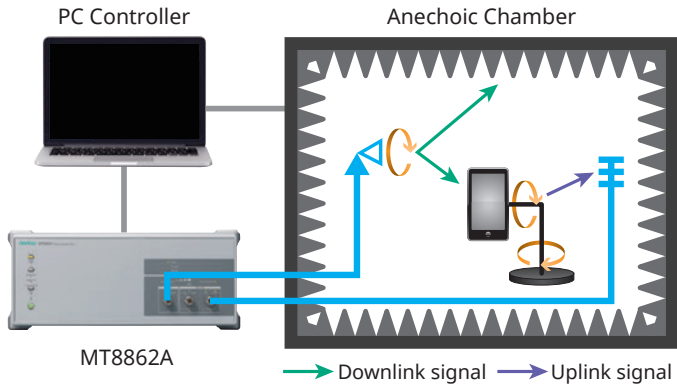

WLAN Measurement Software MX886200A Key Functions

RF Tx Test

Tx Power Measurement and Power Profile Display

The MT8862A measures the Tx power and displays the average and peak power between gate intervals. The gate interval of the Tx power signal can be freely specified based on packets, payload and user definitions. The crest factor indicating the difference between the average power and peak power between gate intervals is also displayed. The power profile is displayed as a graph of the power vs time for the signal between gate intervals.

Output Power Measurements			
Transmit Power			
	Average	Maximum	Minimum
Gate1 Average Power [dBm]	8.48	8.48	8.47
Gate1 Peak Power [dBm]	19.41	19.52	19.35
Crest Factor			
Gate1 [dB]	Average	Maximum	Minimum
	10.94	11.05	10.88

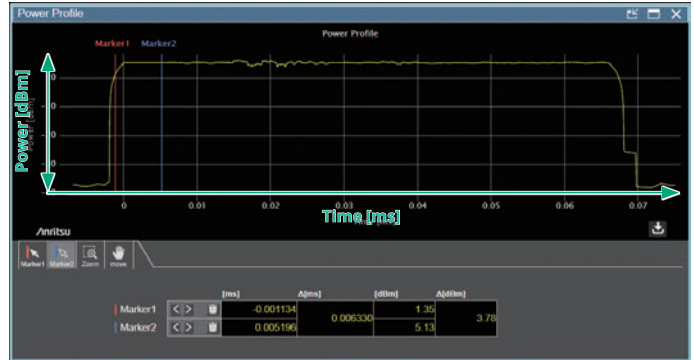

Frequency and Modulation Analysis/IQ Constellation Display/Spectrum Display

The MT8862A performs frequency and modulation analyses to measure the Error Vector Magnitude (EVM), which is a good of overall indicator of transmitter quality. When the numerical EVM is bad, the Packet Error Rate (PER) is usually high at WLAN connection. The average EVM and Peak EVM for DSSS- and OFDM-modulated carrier waves are expressed as % and dB values, respectively. The measurement mode and measurement symbol/chip values can be set freely.

In addition to EVM, the frequency error, symbol clock error, IQ offset, rms phase error, rms amplitude error, phase imbalance, and amplitude imbalance are also displayed. At DSSS modulation, the chip clock error and carrier wave suppression are also displayed. Furthermore, the IQ constellation and spectrum analysis results are displayed as graphs.

Numeric Result	
Auto-ID Information	
Auto-ID Standard	AC
Guard Interval	LONG
PPDU Type	VHT80
MCS Index	8
Coding Type	BCC
PSDU Length	1096
L-SIG Parity Status	PASS
VHT-SIG CRC	PASS
Number of Space Time Streams	1
Output Power Measurements	
Transmit Power	
Gate1 Average Power [dBm]	Average: 8.48, Maximum: 8.48, Minimum: 8.47
Gate1 Peak Power [dBm]	Average: 19.41, Maximum: 19.52, Minimum: 19.35
Crest Factor	
Gate1 [dB]	Average: 10.94, Maximum: 11.05, Minimum: 10.88
Frequency / Modulation Measurements	
EVM	
RMS [dB]	Average: -35.16, Maximum: -34.61, Minimum: -35.86
RMS [%]	Average: 1.75, Maximum: 1.86, Minimum: 1.61
Peak [dB]	Average: -26.86, Maximum: -26.26, Minimum: -27.39
Peak [%]	Average: 4.54, Maximum: 4.86, Minimum: 4.27

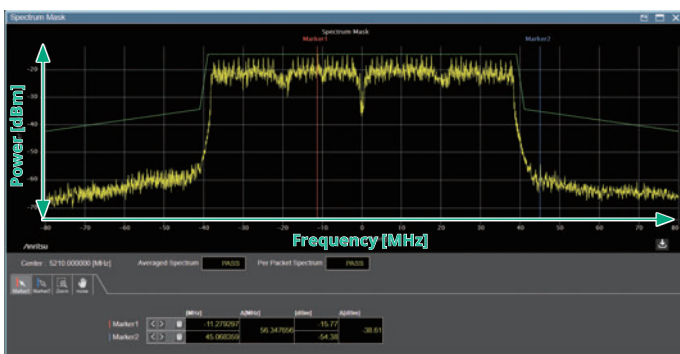
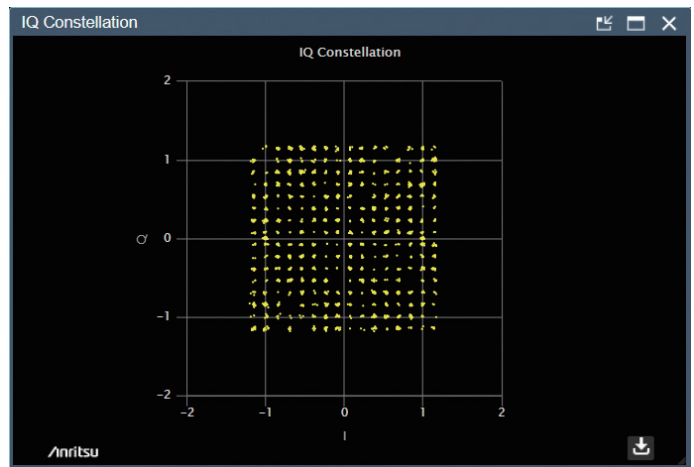

WLAN Measurement Software MX886200A Key Functions

RF Rx Test

Packet Error Rate (PER)

The MT8862A Network Mode is a unique function that eliminates the need for chipset-vendor-provided control software and instead automatically implements the 802.11a/b/g/n/ac device sensitivity search measurement to output the Bathtub curve. By using this function, the device performance can be analyzed at high speed for each data rate, offering a convenient measurement solution for verifying compliance with the 802.11b minimum receiver sensitivity test specifications. This is a flexible test solution because the number of packets sent at each power level can be specified both as the start and stop search level and as step size.

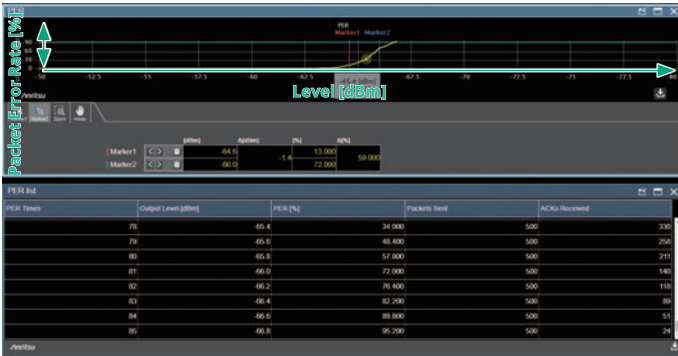

Frame Rx rate (FRR)

The Frame Rx Rate can be displayed instead of displaying the Packet Rx Error Rate (PER).

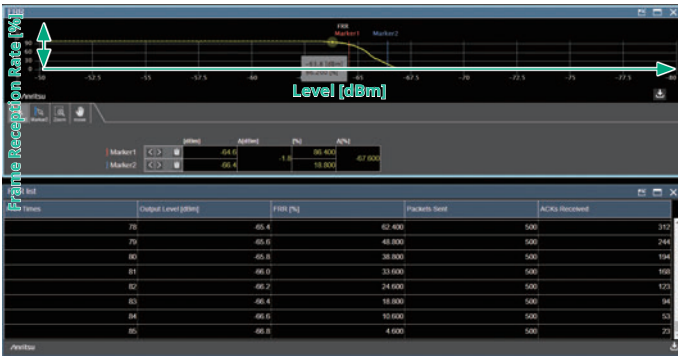

WLAN Measurement Software MX886200A Key Functions

Connectivity

	802.11a
Frequency Range	5180 MHz to 5825 MHz
Operation Mode	—
Modulation	OFDM (BPSK, QPSK, 16QAM, 64QAM)
Data Rate	6, 9, 12, 18, 24, 36, 48, 54 Mbps
Security*2	WEP, WPA-Personal, WPA2-Personal

	802.11b	802.11g
Frequency Range	2412 MHz to 2484 MHz	
Operation Mode	—	ERP-OFDM
Modulation	DSSS, CCK	OFDM (BPSK, QPSK, 16QAM, 64QAM)
Data Rate	1, 2, 5.5, 11 Mbps	6, 9, 12, 18, 24, 36, 48, 54 Mbps
Security*2	WEP, WPA-Personal, WPA2-Personal	

	802.11n	802.11ac*1
Frequency Range	2412 MHz to 2484 MHz and 5180 MHz to 5825 MHz	5180 MHz to 5825 MHz
Bandwidth	20 MHz, 40 MHz	20, 40, 80 MHz
MCS	MCS0 to MCS7	MCS0 to MCS9
FEC	BCC	BCC
PPDU Format	HT-mixed, HT-greenfield	VHT
Guard Interval Type	Long, Short	Long, Short
RF Chain	Single (SISO)	Single (SISO)
Security*2	WPA-Personal, WPA2-Personal	

*1: 802.11ac connection requires MX886200A-001

*2: Secure connections require the MX886200A-020

WLAN Measurement Software MX886200A Measurement Items

Tx Measurements

IEEE802.11-2012: 802.11b Tx Measurements

802.11b	Measurement Item
17.4.7.2	Transmit power levels
17.4.7.4	Transmit spectral mask
17.4.7.5	Transmit center frequency tolerance
17.4.7.6	Chip clock frequency tolerance
17.4.7.7	Transmit power-on and power-down ramp*
17.4.7.9	Transmit modulation accuracy

*: To be supported by MT8862A in future update

Other 802.11b Measurements

Measurement Item
Transmit power
Crest Factor
EVM (Transmit modulation accuracy)
Center frequency tolerance
IQ Offset
Phase Error
Magnitude Error
Amplitude Imbalance
Phase Imbalance
Chip clock frequency tolerance
Carrier Suppression from IQ Offset

Graph Display (DSSS)

Measurement Item
IQ Constellation
Power Profile
Spectrum

IEEE802.11-2012: 802.11a/g/n Tx Measurements, IEEE802.11ac-2013: 802.11ac Tx Measurements

802.11a	802.11g	802.11n	802.11ac*1	Measurement Item
18.3.9.2	19.4.8.2	20.3.20.3	N/A	Transmit power levels
18.3.9.3	19.5.5	20.3.20.1	22.3.18.1	Transmit spectrum mask*2
18.3.9.5	19.4.8.3	20.3.20.4	22.3.18.3	Transmit center frequency tolerance
18.3.9.6	19.4.8.4	20.3.20.6	22.3.18.3	Symbol clock frequency tolerance
18.3.9.7.2	18.3.9.7.2	20.3.20.7.2	22.3.18.4.2	Transmitter center frequency leakage*3
18.3.9.7.3	18.3.9.7.3	20.3.20.2	20.3.18.2	Transmitter spectral flatness*3
18.3.9.7.4	18.3.9.7.4	20.3.20.7.3	22.3.18.4.3	Transmitter constellation error
18.3.9.8	18.3.9.8	20.3.20.7.4	22.3.18.4.4	Transmitter modulation accuracy test

*1: 802.11ac Tx measurement requires MX886200A-001

*2: Frequency SPAN of 802.11ac supports up to ±80 MHz

*3: To be supported by MT8862A in future update

Other 802.11a/g/n/ac Measurements

Measurement Item
Transmit power
Crest Factor
EVM (Transmit modulation accuracy)
Center frequency tolerance
Symbol clock frequency tolerance
Amplitude Imbalance
Phase Imbalance
Phase Error

Graph Display (OFDM)

Measurement Item
IQ Constellation
Power Profile
Spectrum

WLAN Measurement Software MX886200A Measurement Items

Rx Measurements

IEEE802.11-2012: 802.11b Rx Measurements

802.11b	Measurement Item
17.4.8.2	Receiver minimum input level sensitivity
17.4.8.3	Receiver maximum input level
17.4.8.4	Receiver adjacent channel rejection*

*: Sold separately; requires signal generator

IEEE802.11-2012: 802.11a/g/n Rx Measurements; IEEE802.11ac-2013: 802.11ac Rx Measurements

802.11a	802.11g	802.11n	802.11ac*1	Measurement Item
18.3.10.2	19.5.2	20.3.21.1	22.3.19.1	Receiver minimum input level sensitivity
18.3.10.3	19.5.3	20.3.21.2	22.3.19.2	Adjacent channel rejection*2
18.3.10.4	18.3.10.4	20.3.21.3	22.3.19.3	Nonadjacent channel rejection*2
18.3.10.5	19.5.4	20.3.21.4	22.3.19.4	Receiver maximum input level

*1: 802.11ac Rx measurement requires MX886200A-001

*2: Sold separately; requires signal generator

Graph Display

Measurement Item
Packet Error Rate (PER)
Frame Reception Rate (FRR)

Wireless Connectivity Test Set MT8862A Configuration

System Configurations/Options/Software/PC Controller Operation Environment

System	Wireless LAN
Main Frame	Wireless Connectivity Test Set MT8862A
Basic Configuration (Hardware)	RF Frequency 2.4 GHz, 5 GHz MT8862A-001
Basic Configuration (Software)	WLAN Measurement Software MX886200A
Options	WLAN 802.11ac Option MX886200A-001 WLAN Security Function MX886200A-020

Verified PC Operation Environment

PC	Software OS: Windows 7 or 10 Browser: Chrome CPU: Intel Core i5 processor Clock: 2.5 GHz Memory: 1 GB minimum Hard Disk: 500 MB minimum free space LAN: 100 Base-T LAN (1000-base T preferred)
Peripherals	Display: WXGA 1024 × 768 minimum

Wireless Connectivity Test Set MT8862A Panel Layout

Front Panel



1 Power switch

Turns the power On or Off.
Off: Power is Off, Green: Power is On.

2 Standby lamp

The power is supplied to the AC inlet and the power switch can be turned On.

3 Access lamp

Green: Accessing the built-in storage device.

4 IP Address Reset key

Long-pressing this switch resets the network settings such as IP address to defaults.

5 External Ref. lamp

Indicates status of external reference signal.

6 System Error lamp

Indicates errors of the unit.

7 Local key

Reset the remote control state by Ethernet to local and enable panel setting.

8 Remote lamp

Off: Local control.
Green: Remote control.

9 Preset key

Long-pressing this switch resets the parameter settings to defaults.

10 Ready lamp/Connect lamp/ Measure lamp

Ready lamp: Indicates the MT8862A startup state.
Connect lamp: Indicates the connection state between MT8862A and DUT.
Measure lamp: Indicates the MT8862A measurement state.

11 Input Signal Level lamp

Indicates the input signal level.

12 RF Output On/Off lamp

Indicates setting state of RF output.

13 Main In/Out 1, 2 connector/Aux Out connector/ Output lamp/Input lamp

Main In/Out 1, 2 connector: Inputs or outputs RF signal.
Aux Out connector: Outputs RF signal.
Output lamp: Indicates the connector's setting state.
Input lamp: Indicates the connector's setting state.

Wireless Connectivity Test Set MT8862A Panel Layout

Rear Panel

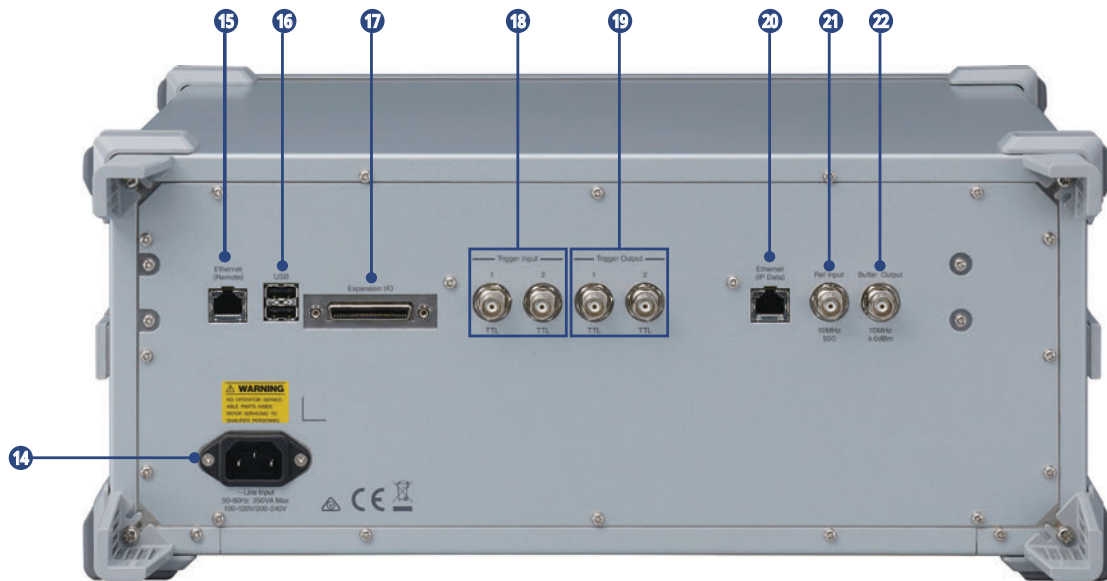

14 AC inlet

AC power inlet for the power cable.

15 Ethernet (Remote) connector

Connect a personal computer (PC) or Ethernet network for remote control.

16 USB connector (A type)

Connector for feature expansion.
Currently not supported.

17 Expansion I/O connector

Connector for feature expansion.
Currently not supported.

18 Trigger Input

Inputs external trigger signals (TTL).
(BNC connector)

19 Trigger Output

Outputs trigger signals (TTL).
(BNC connector)

20 Ethernet (IP Data) connector

Connects a PC or Ethernet network for IP Data input/output.

21 Reference Input connector

Inputs an external reference frequency signal (10 MHz).
(BNC connector)

22 Buffer Output connector

Outputs the reference frequency signal (10 MHz).
(BNC connector)

Wireless Connectivity Test Set MT8862A Specifications

Typical value: Reference data and not assured value

Receiver	<p>Frequency Range: 2.4 GHz to 2.5 GHz, 5.0 GHz to 6.0 GHz (with MT8862A-001 installed) Resolution: 1 Hz Accuracy: Depends on reference oscillator accuracy</p> <p>Level Setting Range: -65 to +25 dBm Setting Resolution: 0.1 dB</p> <p>Accuracy Measurement Conditions: CW, Measurement Bandwidth: 300 kHz, 20° to 30°C 2.4 GHz ≤ Frequency ≤ 2.5 GHz ±0.7 dB (-30 dBm ≤ Setting Level ≤ +25 dBm) ±0.9 dB (-55 dBm ≤ Setting Level < -30 dBm) ±1.1 dB (-65 dBm ≤ Setting Level < -55 dBm) 5.0 GHz ≤ Frequency ≤ 6.0 GHz ±0.7 dB (-30 dBm ≤ Setting Level ≤ +25 dBm) ±0.9 dB (-55 dBm ≤ Setting Level < -30 dBm) ±1.1 dB (-65 dBm ≤ Setting Level < -55 dBm)</p> <p>Measurement Conditions: CW, Measurement Bandwidth: 160 MHz, 20° to 30°C 2.4 GHz ≤ Frequency ≤ 2.5 GHz ±0.7 dB (-30 dBm ≤ Setting Level ≤ +25 dBm) ±1.0 dB (-50 dBm ≤ Setting Level < -30 dBm) 5.0 GHz ≤ Frequency ≤ 6.0 GHz ±0.7 dB (-30 dBm ≤ Setting Level ≤ +25 dBm) ±1.0 dB (-50 dBm ≤ Setting Level < -30 dBm)</p> <p>Linearity Measurement Conditions: CW, Measurement Bandwidth: 300 kHz, 0 dB ≤ Setting Level ≤ -40 dB ±0.2 dB (-55 dBm ≤ Input Level) ±0.4 dB (-65 dBm ≤ Input Level < -55 dBm)</p> <p>Measurement Conditions: CW, Measurement Bandwidth: 160 MHz, 0 dB ≤ Setting Level ≤ -30 dB ±0.4 dB (-40 dBm ≤ Input Level)</p>
Transmitter	<p>Frequency Output Frequency Range: 2.4 GHz to 2.5 GHz, 5.0 GHz to 6.0 GHz (with MT8862A-001 installed) Setting Resolution: 1 Hz Accuracy: Depends on reference oscillator accuracy</p> <p>Level Setting Range: -120 to 0 dBm Setting Resolution: 0.1 dB</p> <p>Accuracy Output Setting: CW 20° to 30°C, Output Level: ≥ -110 dBm, after Calibration ±1.0 dB, ±0.7 dB (typ.) (2.4 GHz ≤ Frequency ≤ 2.5 GHz) ±1.3 dB, ±1.0 dB (typ.) (5.0 GHz ≤ Frequency ≤ 6.0 GHz)</p> <p>Signal Purity Harmonic: ≤ -25 dBc</p>
Reference Oscillator	<p>At Start: $\pm 5 \times 10^{-7}$ (2 minutes after power-on, at 25°C referenced to frequency at 24 hour after power-on) $\pm 5 \times 10^{-8}$ (5 minutes after power-on, at 25°C referenced to frequency at 24 hour after power-on)</p> <p>Aging Rate: $\pm 1 \times 10^{-7}$/year Temperature Characteristics: $\pm 2 \times 10^{-8}$ (5° to 45°C) Shipped Frequency Accuracy: $\pm 2.2 \times 10^{-8}$ (1 hour after power-on at 20° to 30°C)</p>

Wireless Connectivity Test Set MT8862A Specifications

Front Panel Connectors	<p>RF Input/Output Main1, 2 Connector: N-J, 50Ω (nominal) VSWR: ≤1.5 (2.4 GHz ≤ Frequency ≤ 2.5 GHz) ≤1.7 (5.0 GHz ≤ Frequency ≤ 6.0 GHz)</p> <p>Aux Out Connector: N-J, 50Ω (nominal) VSWR: ≤1.5 (2.4 GHz ≤ Frequency ≤ 2.5 GHz) ≤1.6 (5.0 GHz ≤ Frequency ≤ 6.0 GHz)</p>
Back Panel Connectors	<p>Reference Signal External Reference Input Connector: BNC-J Frequency: 10 MHz, Impedance: 50Ω Operation range: ±1 ppm, Input Level: -15 dBm ≤ Level ≤+20 dBm, 50Ω (AC coupled)</p> <p>Reference Signal Output Connector: BNC-J Frequency: 10 MHz, Impedance: 50Ω Output Level: ≥0 dBm (AC coupled))</p> <p>External Trigger Trigger Input 1/2 Connector: BNC 1/2, Input Level: TTL</p> <p>Trigger Output 1/2 Connector: BNC 1/2, Output Level: TTL</p> <p>External Interfaces Ethernet (Remote): Required for remote control from external controller Connector: RJ-45, Speed: 1000BASE-T</p> <p>USB: General Purpose, USB 2.0 Connector: USB-A, 2 Ports</p> <p>Expansion I/O: Connector for function expansion Connector: 50 pin (DX10A-50S)</p> <p>Ethernet (IP Data): IP Data Transfer Connector: RJ-45, Speed: 1000BASE-T</p>
Dimensions and Mass	426 (W) × 177 (H) × 390 (D) mm (excluding projections), ≤14 kg
Power Supply	<p>Rated voltage: 100 V(ac) to 120 V(ac) or 200 V(ac) to 240 V(ac)</p> <p>Rated frequency: 50 Hz/60 Hz</p> <p>Power consumption: ≤350 VA</p>
Operating Conditions	<p>Temperature Operating: +5° to +45°C, Storage: -20° to +60°C</p>
CE	<p>EMC: EN61326-1, EN61000-3-2</p> <p>LVD: EN61010-1</p> <p>RoHS: EN50581</p>

WLAN Measurement Software MX886200A Specifications

Frequency Range	2.4 GHz Band: 2412 MHz to 2484 MHz 5 GHz Band: 5180 MHz to 5825 MHz
Amplitude Measurement	Input Level Range: -50 to +25 dBm Input Level Accuracy: ± 0.7 dB (-30 dBm \leq Input Level \leq +25 dBm), ± 1.0 dB (-50 dBm \leq Input Level < -30 dBm), After Calibration at 20° to 30°C Linearity: ± 0.4 dB (-40 dBm \leq Input Level, 0 to -30 dB range compared to setting level) Bandwidth: 40 MHz/20 MHz (802.11n), 20 MHz (802.11a/b/g), 80/40/20 MHz (802.11ac, with MX886200A-001 installed)
Spectrum Measurement	Input Level Range: -10 to +25 dBm
EVM (Modulation Accuracy)	EVM Measurement Range: -20 to +25 dBm Residual EVM DSSS: < -28 dB (-20 dBm \leq Input Level, Average of 20 Packets) OFDM (802.11a/g/n): < -40 dB (-20 dBm \leq Input Level, Average of 20 Packets, Channel Estimate: Full Packets) OFDM (802.11ac, with MX886200A-001 installed): < -38 dB (-10 dBm \leq Input Level, Average of 20 Packets, Channel Estimate: Full Packets) EVM Data Format: % or dB Measurement Resolution: 0.01% or 0.01 dB
Carrier Frequency Measurement	Measurement Level Range: -20 to +25 dBm Carrier Frequency Accuracy: \pm (Setting Frequency \times Reference Oscillator Accuracy +1 kHz) (Average of 20 Packets, DSSS) \pm (Setting Frequency \times Reference Oscillator Accuracy +1 kHz) (Average of 20 Packets, Channel Estimate: Full Packets, OFDM)
RF Signal Generator	EVM: Packet Length 1472 byte 802.11b: ≤ -38 dB rms (2412 MHz to 2484 MHz, Long Preamble, Gaussian Filter BT0.5, 5° to 45°C) 802.11g (OFDM): ≤ -40 dB rms (2412 MHz to 2484 MHz, 20° to 30°C) 802.11a: ≤ -38 dB rms (5180 MHz to 5825 MHz) 802.11n: ≤ -40 dB rms (2412 MHz to 2484 MHz, Long GI, HT-mixed format, Channel Bandwidth 40 MHz, 20° to 30°C) ≤ -38 dB rms (5180 MHz to 5825 MHz, Long GI, HT-mixed format, Channel Bandwidth 40 MHz, 20° to 30°C) 802.11ac (with MX886200A-001 installed): ≤ -37 dB rms (5180 MHz to 5825 MHz, Long GI, Channel Bandwidth 80 MHz, 20° to 30°C)
Functions	Network Functions Connection: Network Connection using Messages defined by IEEE802.11 Role: Access Point (AP) Frame Capture: 1, 2, 4, 8, 16, 32, 64, 128, 256 MB Tx Test Measurement Type: Data, ACK Rx Test Measurement Type: Packet Error Rate (PER), Frame Reception Rate (FRR) Payload Type: All 0's, 0101, 1010, PN7, PN9, Random, Counting Security encryption (with MX886200A-020 installed) WEP, WPA-Personal, WPA2-Personal

Wireless Connectivity Test Set MT8862A Ordering Information

Please specify the model/order number, name and quantity when ordering.

The names listed in the chart below are Order Names. The actual name of the item may differ from the Order Name.

Model/Order No.	Name
MT8862A	Main frame Wireless Connectivity Test Set
J0017F	Standard accessories Power Code (2.6 m, 100 V, 3-core, Grey): 1 Manual Operation DVD: 1
W3901AE	MT8862A Operation Manual (Operation)
W3902AE	MT8862A Operation Manual (Remote Control)
W3903AE	MX886200A WLAN Measurement Software Manual (Operation)
W3904AE	MX886200A WLAN Measurement Software Manual (Remote Control)
MT8862A-001	Options RF Frequency 2.4 GHz, 5 GHz
MX886200A	Software Options WLAN Measurement Software (Requires MT8862A-001)
MX886200A-001	WLAN 802.11ac Option
MX886200A-020	WLAN Security Function
MT8862A-ES210	Options 2 Years Extended Warranty Service
MT8862A-ES310	3 Years Extended Warranty Service
MT8862A-ES510	5 Years Extended Warranty Service
J0127A	Application parts Coaxial Cord, 1 m (BNC-P, RG-58A/U, BNC-P)
J0127B	Coaxial Cord, 2 m (BNC-P, RG-58A/U, BNC-P)
J0127C	Coaxial Cord, 0.5 m (BNC-P, RG-58A/U, BNC-P)
J0576B	Coaxial Cord, 1 m (N-P, 5D-2W, N-P)
J0576D	Coaxial Cord, 2 m (N-P, 5D-2W, N-P)
J0322A	Coaxial Cord, 0.5 m (SMA-P, SMA-P)
J0322B	Coaxial Cord, 1.0 m (SMA-P, SMA-P)
J0322C	Coaxial Cord, 1.5 m (SMA-P, SMA-P)
J0322D	Coaxial Cord, 2.0 m (SMA-P, SMA-P)
J0004	Coaxial Adapter (N-P, SMA-J)
J1261A	Ethernet Cable (Straight, 1 m)
J1261B	Ethernet Cable (Straight, 3 m)
J1261C	Ethernet Cable (Cross, 1 m)
J1261D	Ethernet Cable (Cross, 3 m)
B0635A	Rack Mount Kit (EIA)
B0657A	Rack Mount Kit (JIS)
B0636C*	Carrying Case (Hard type, with a front cover and casters)
B0671A	Front Cover (1MW4U)

*: The Carrying Case B0636C includes a Front Panel Protective Cover (B0671A).

• United States

Anritsu Company

1155 East Collins Blvd., Suite 100, Richardson,
TX 75081, U.S.A.

Toll Free: 1-800-267-4878

Phone: +1-972-644-1777

Fax: +1-972-671-1877

• Canada

Anritsu Electronics Ltd.

700 Silver Seven Road, Suite 120, Kanata,

Ontario K2V 1C3, Canada

Phone: +1-613-591-2003

Fax: +1-613-591-1006

• Brazil

Anritsu Eletronica Ltda.

Praça Amadeu Amaral, 27 - 1 Andar

01327-010 - Bela Vista - Sao Paulo - SP

Brazil

Phone: +55-11-3283-2511

Fax: +55-11-3288-6940

• Mexico

Anritsu Company, S.A. de C.V.

Av. Ejército Nacional No. 579 Piso 9, Col. Granada

11520 México, D.F., México

Phone: +52-55-1101-2370

Fax: +52-55-5254-3147

• United Kingdom

Anritsu EMEA Ltd.

200 Capability Green, Luton, Bedfordshire, LU1 3LU, U.K.

Phone: +44-1582-433200

Fax: +44-1582-731303

• France

Anritsu S.A.

12 avenue du Québec, Bâtiment Iris 1- Silic 612,

91140 VILLEBON SUR YVETTE, France

Phone: +33-1-60-92-15-50

Fax: +33-1-64-46-10-65

• Germany

Anritsu GmbH

Nemetschek Haus, Konrad-Zuse-Platz 1

81829 München, Germany

Phone: +49-89-442308-0

Fax: +49-89-442308-55

• Italy

Anritsu S.r.l.

Via Elio Vittorini 129, 00144 Roma, Italy

Phone: +39-6-509-9711

Fax: +39-6-502-2425

• Sweden

Anritsu AB

Kistagången 20B, 164 40 KISTA, Sweden

Phone: +46-8-534-707-00

Fax: +46-8-534-707-30

• Finland

Anritsu AB

Teknobulevardi 3-5, FI-01530 VANTAA, Finland

Phone: +358-20-741-8100

Fax: +358-20-741-8111

• Denmark

Anritsu A/S

Kay Fiskers Plads 9, 2300 Copenhagen S, Denmark

Phone: +45-7211-2200

Fax: +45-7211-2210

• Russia

Anritsu EMEA Ltd.

Representation Office in Russia

Tverskaya str. 16/2, bld. 1, 7th floor.

Moscow, 125009, Russia

Phone: +7-495-363-1694

Fax: +7-495-935-8962

• Spain

Anritsu EMEA Ltd.

Representation Office in Spain

Edificio Cuzco IV, Po. de la Castellana, 141, Pta. 5

28046, Madrid, Spain

Phone: +34-915-726-761

Fax: +34-915-726-621

• United Arab Emirates

Anritsu EMEA Ltd.

Dubai Liaison Office

902, Aurora Tower,

P O Box: 500311 - Dubai Internet City

Dubai, United Arab Emirates

Phone: +971-4-3758479

Fax: +971-4-4249036

• India

Anritsu India Private Limited

2nd & 3rd Floor, #837/1, Binnamangla 1st Stage,

Indiranagar, 100ft Road, Bangalore - 560038, India

Phone: +91-80-4058-1300

Fax: +91-80-4058-1301

• Singapore

Anritsu Pte. Ltd.

11 Chang Charn Road, #04-01, Shriro House

Singapore 159640

Phone: +65-6282-2400

Fax: +65-6282-2533

• P.R. China (Shanghai)

Anritsu (China) Co., Ltd.

Room 2701-2705, Tower A,

New Caohejing International Business Center

No. 391 Gui Ping Road Shanghai, 200233, P.R. China

Phone: +86-21-6237-0898

Fax: +86-21-6237-0899

• P.R. China (Hong Kong)

Anritsu Company Ltd.

Unit 1006-7, 10/F., Greenfield Tower, Concordia Plaza,

No. 1 Science Museum Road, Tsim Sha Tsui East,

Kowloon, Hong Kong, P.R. China

Phone: +852-2301-4980

Fax: +852-2301-3545

• Japan

Anritsu Corporation

8-5, Tamura-cho, Atsugi-shi, Kanagawa, 243-0016 Japan

Phone: +81-46-296-6509

Fax: +81-46-225-8352

• Korea

Anritsu Corporation, Ltd.

5FL, 235 Pangyoyeok-ro, Bundang-gu, Seongnam-si,

Gyeonggi-do, 13494 Korea

Phone: +82-31-696-7750

Fax: +82-31-696-7751

• Australia

Anritsu Pty. Ltd.

Unit 20, 21-35 Ricketts Road,

Mount Waverley, Victoria 3149, Australia

Phone: +61-3-9558-8177

Fax: +61-3-9558-8255

• Taiwan

Anritsu Company Inc.

7F, No. 316, Sec. 1, NeiHu Rd., Taipei 114, Taiwan

Phone: +886-2-8751-1816

Fax: +886-2-8751-1817